

AX1

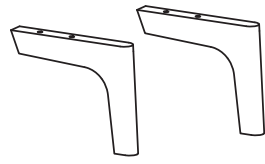

BX2

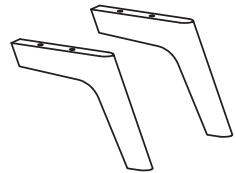

CX2

069569  
PUZZLE WOOD

1

CLICK

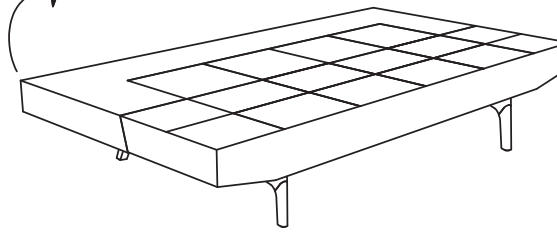

SOVE-SCHLAFEN-SLEEP-DORMIR

2

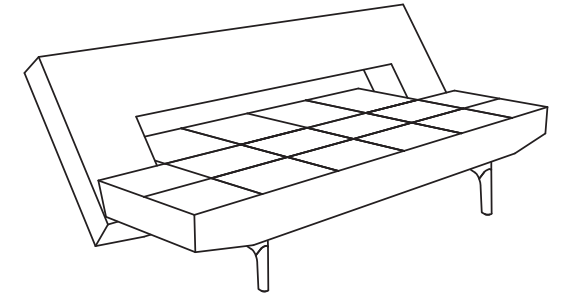

HVILE-RUHE-RELAX-REPOSER

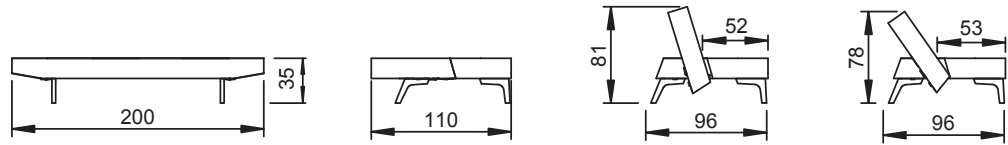

2,54CM=1 US INCH

3

CLICK

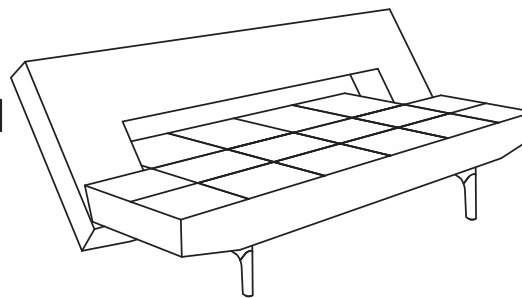

HVILE-RUHE-RELAX-REPOSER

4

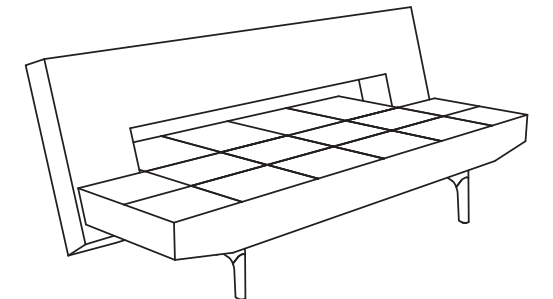

SIDDE-SITZEN-SIT-ASSISE

1

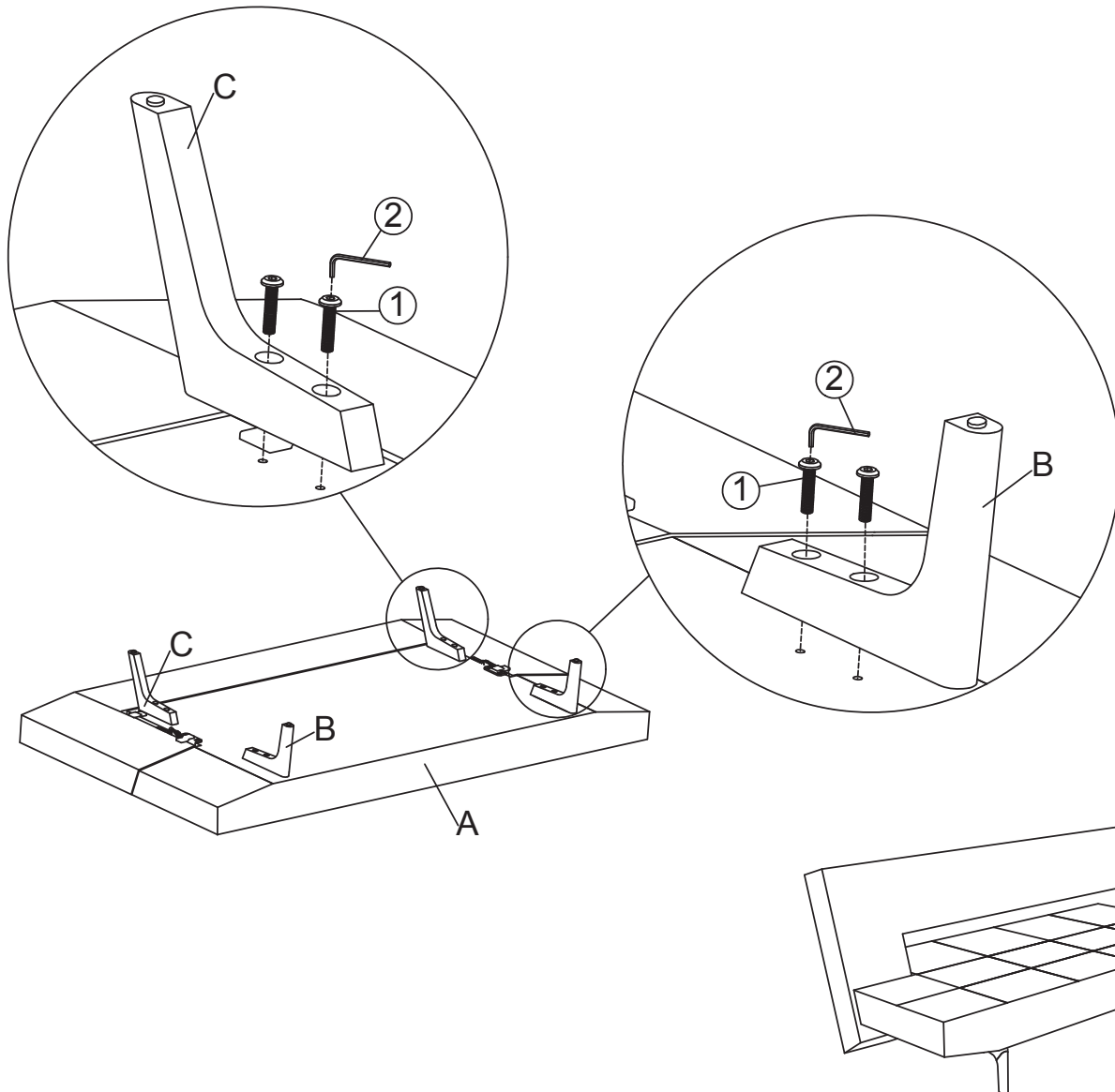

5

CLICK

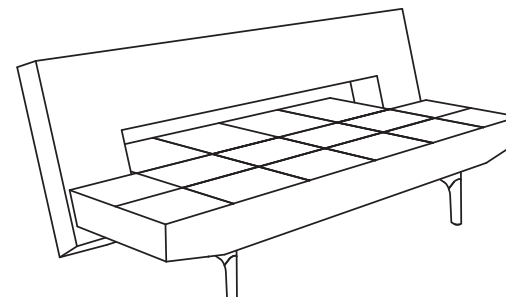

SIDDE-SITZEN-SIT-ASSISE

6

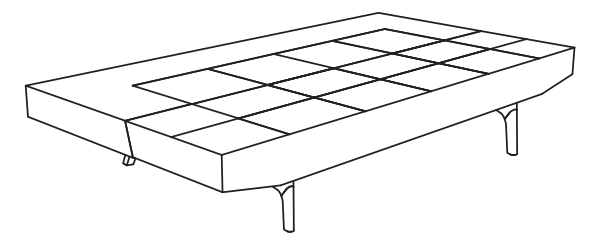

SOVE-SCHLAFEN-SLEEP-DORMIR